

Hashi – Pack 22

Puzzle 1 (7x7)

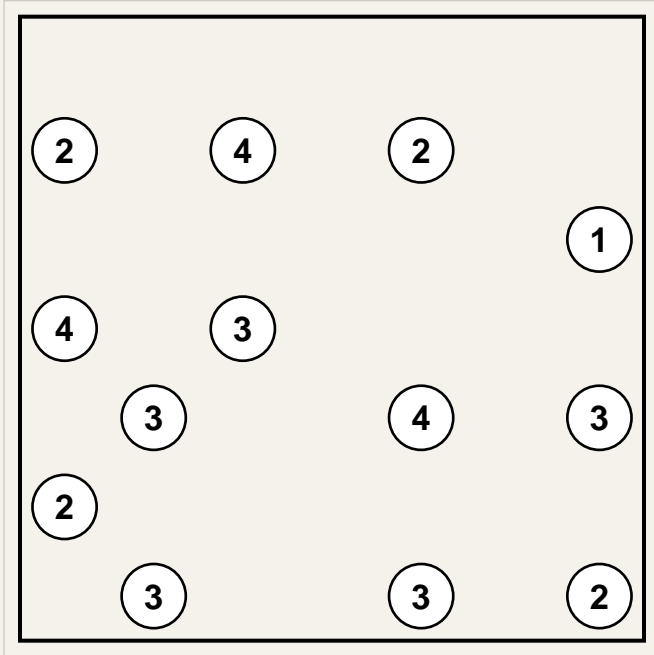

Puzzle 2 (10x10)

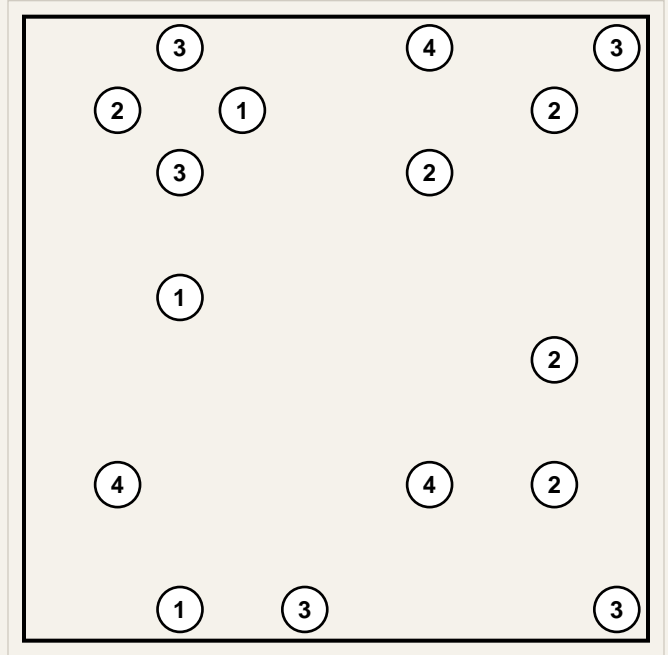

Puzzle 3 (7x7)

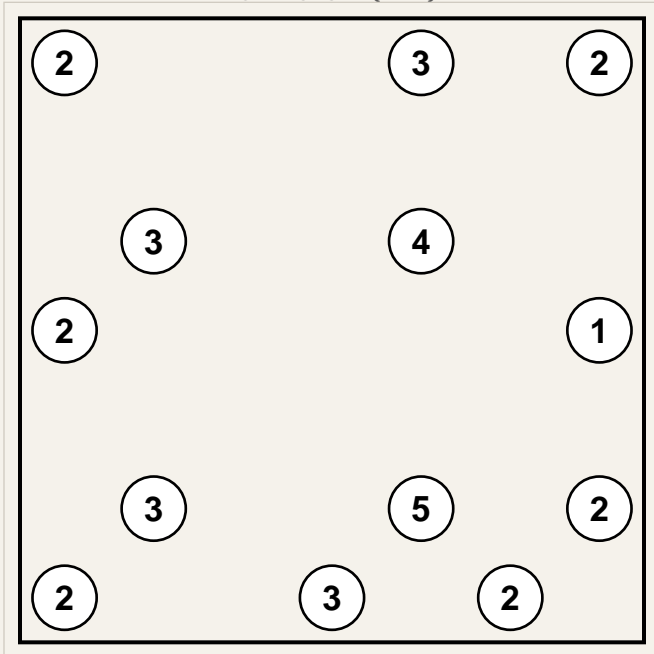

Puzzle 4 (7x7)

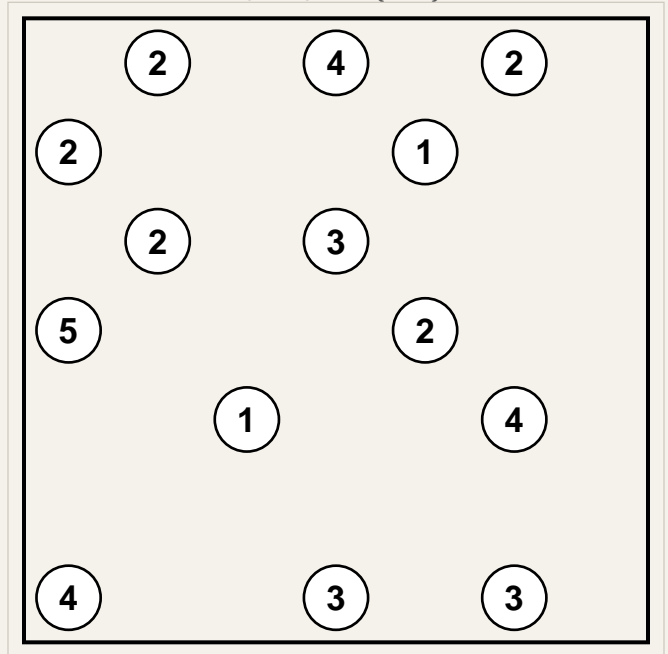

Hashi – Pack 22

Puzzle 5 (10×10)

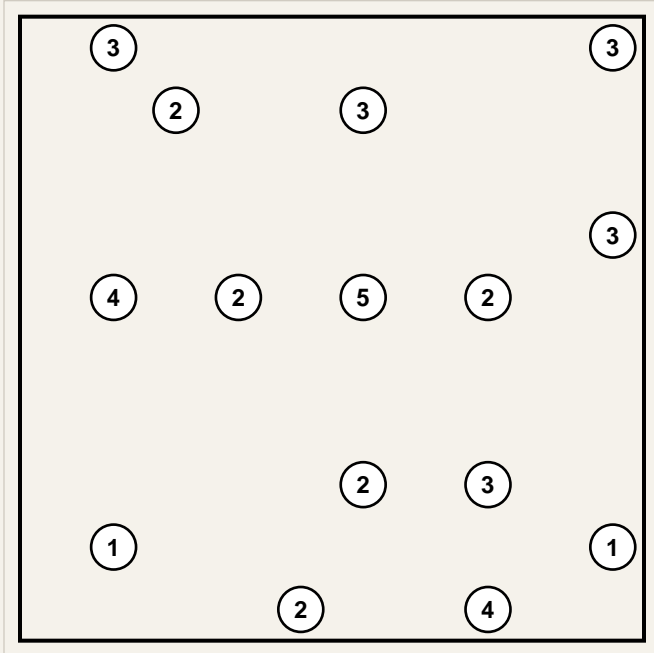

Puzzle 6 (7×7)

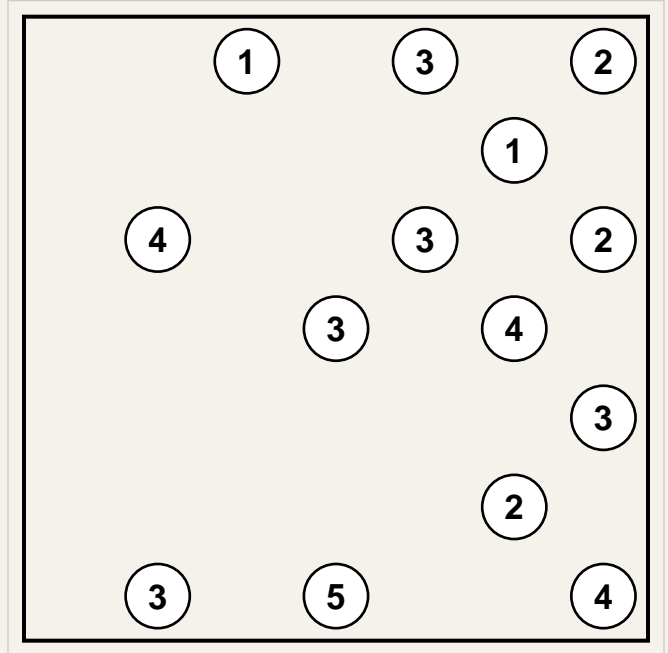

Puzzle 7 (10×10)

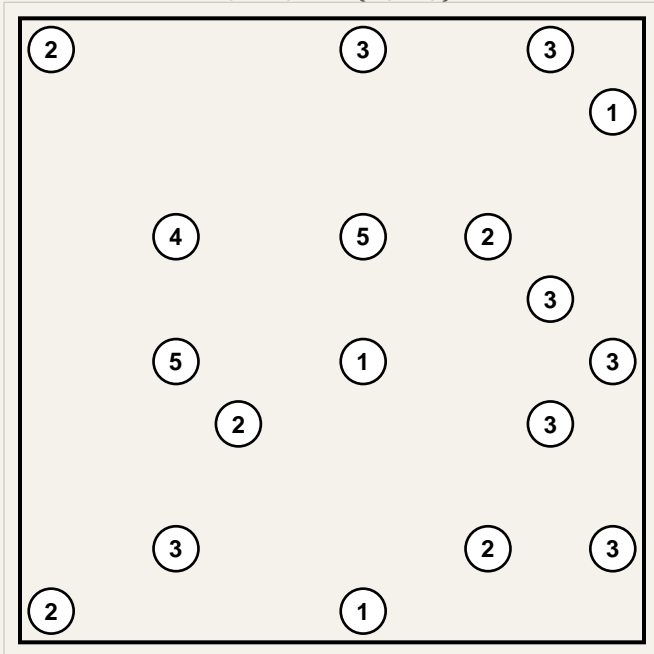

Puzzle 8 (7×7)

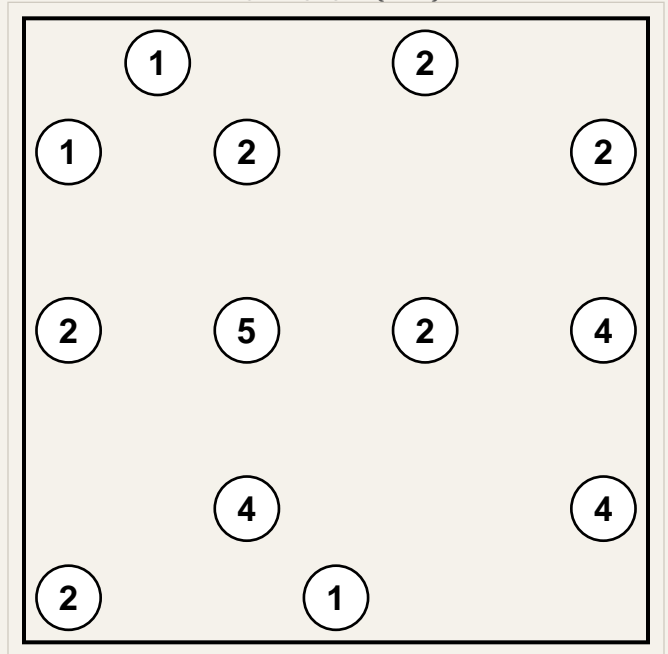

Answer Key

Puzzle 1

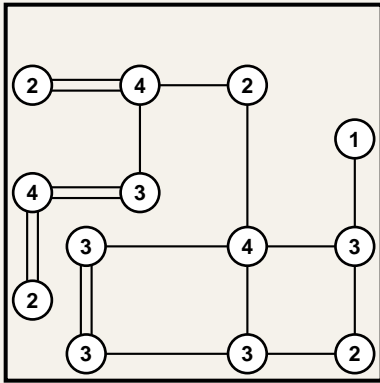

Puzzle 2

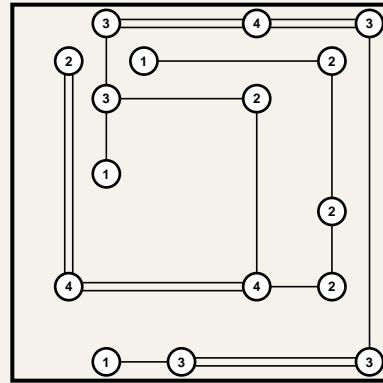

Puzzle 3

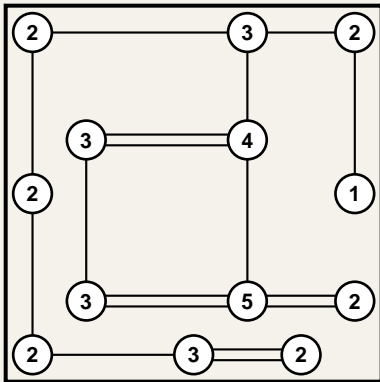

Puzzle 4

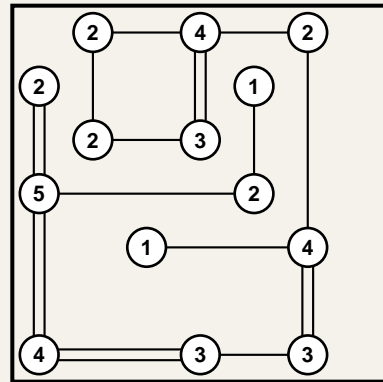

Puzzle 5

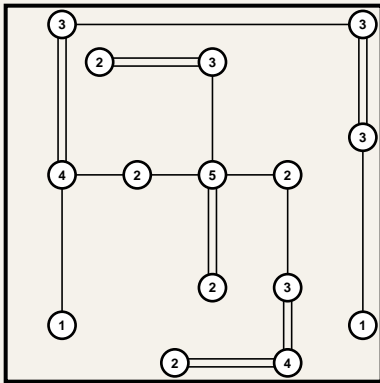

Puzzle 6

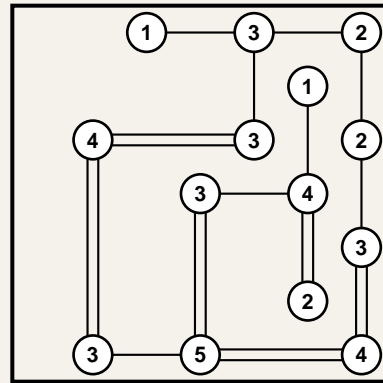

Puzzle 7

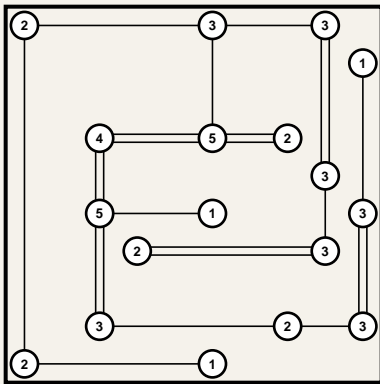

Puzzle 8

