

Hashi – Pack 8

Puzzle 1 (10×10)

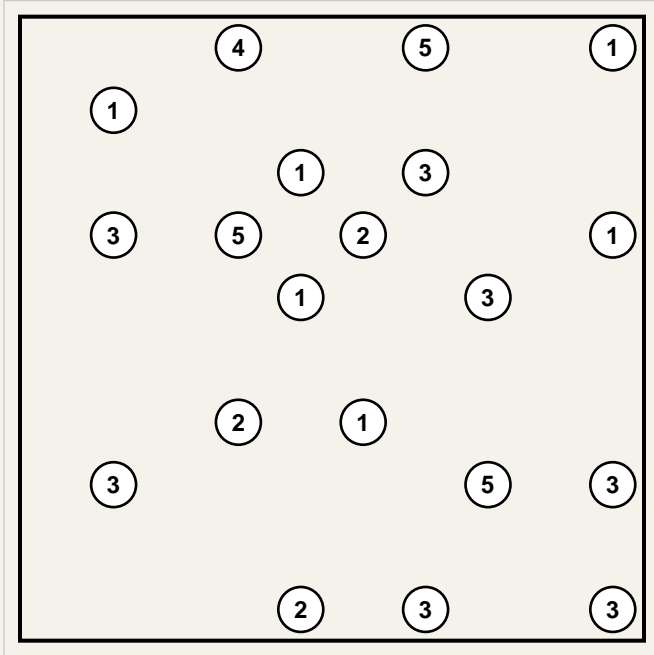

Puzzle 2 (10×10)

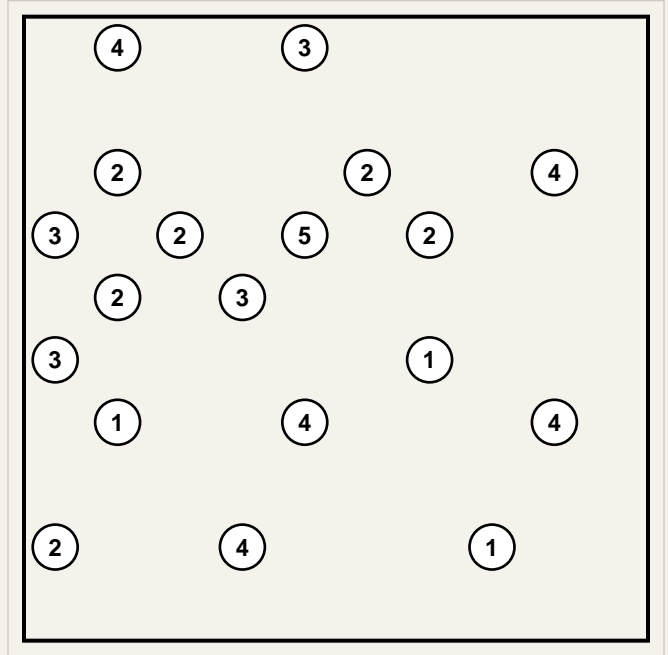

Puzzle 3 (10×10)

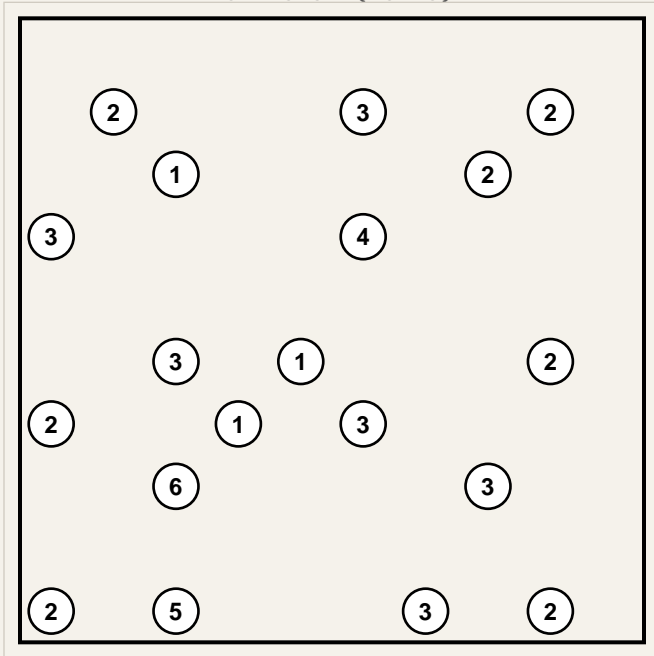

Puzzle 4 (15×15)

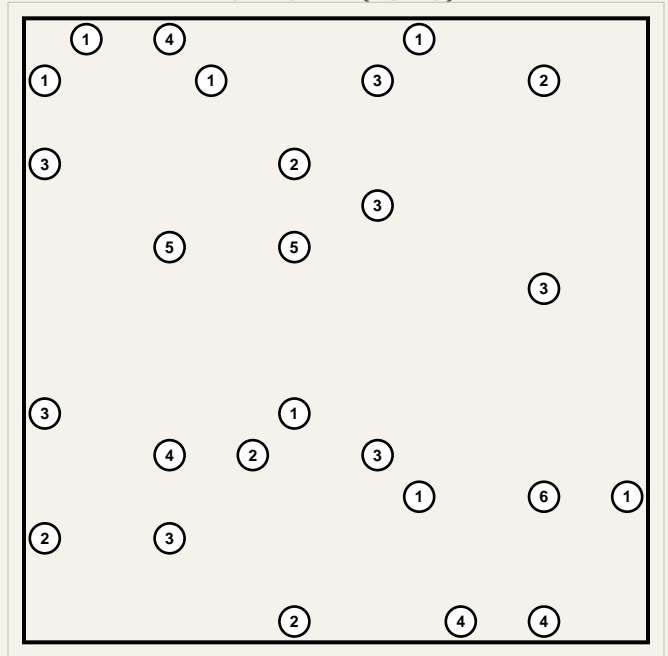

Hashi – Pack 8

Puzzle 5 (15×15)

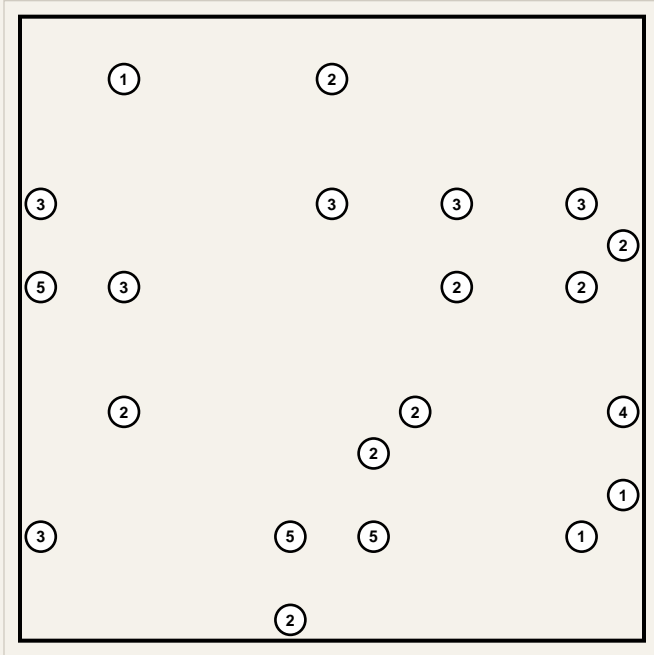

Puzzle 6 (10×10)

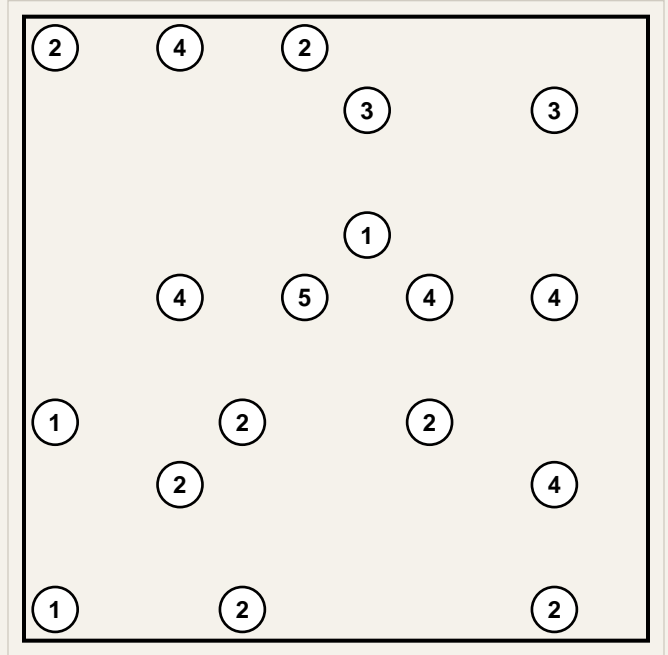

Puzzle 7 (15×15)

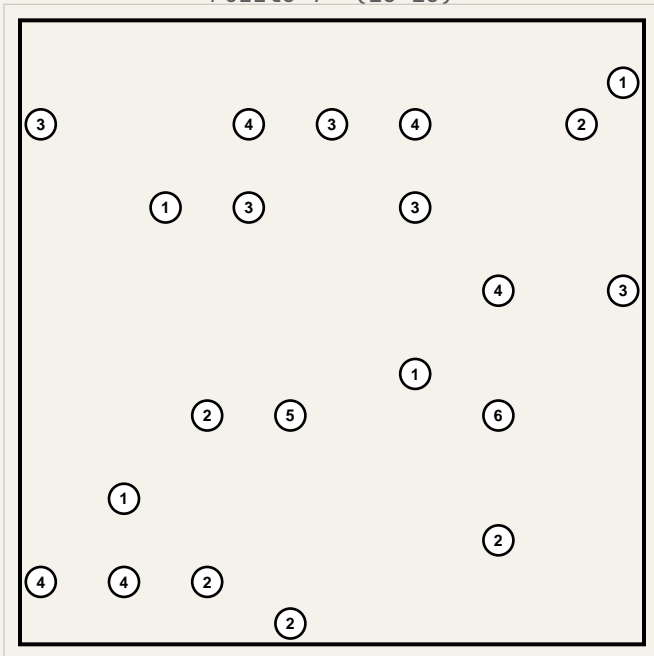

Puzzle 8 (10×10)

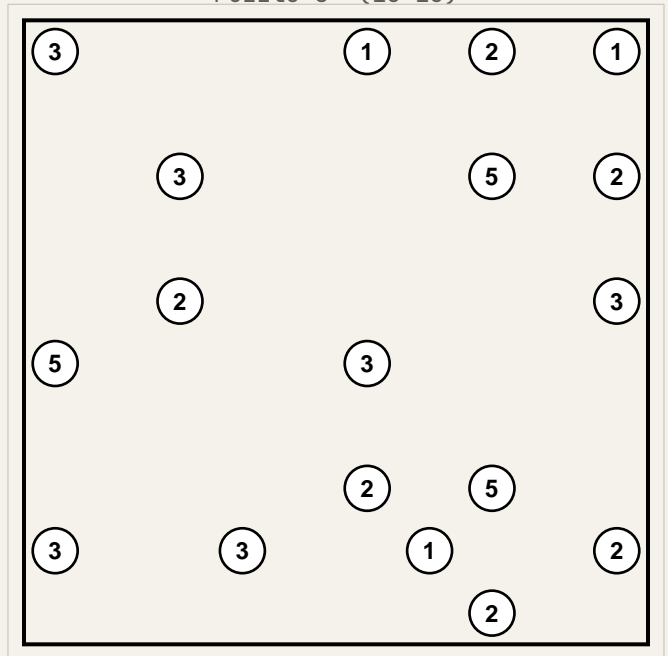

### Answer Key

Puzzle 1

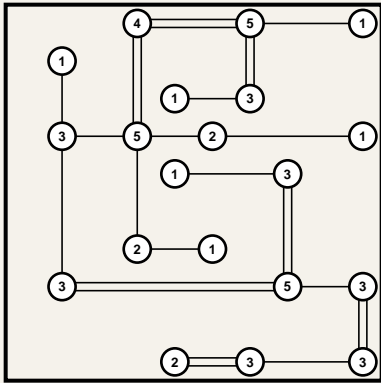

Puzzle 2

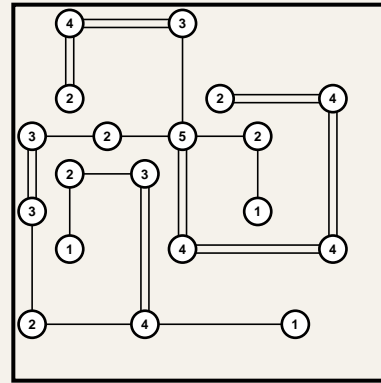

Puzzle 3

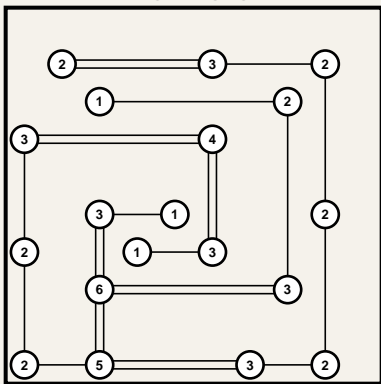

Puzzle 4

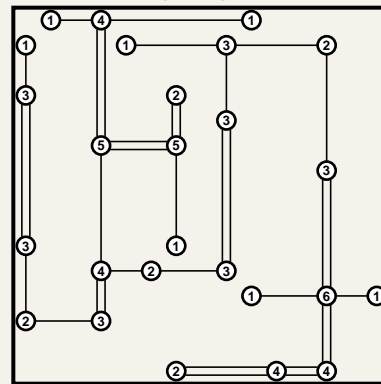

Puzzle 5

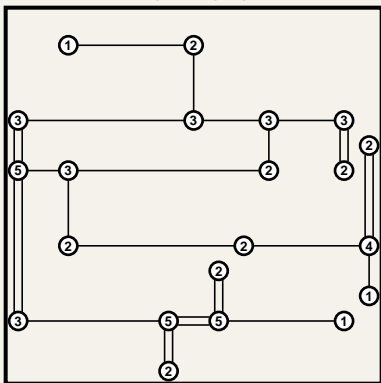

Puzzle 6

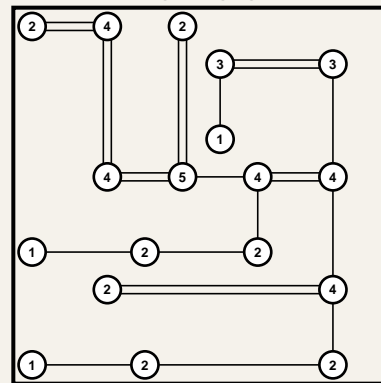

Puzzle 7

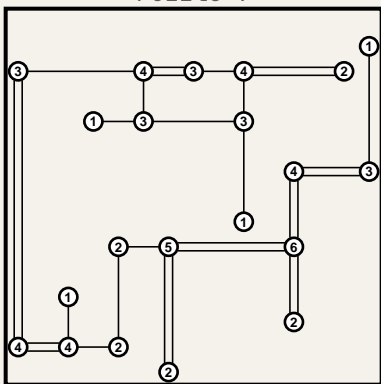

Puzzle 8

